

Job:
Type:
Notes:

Featuring the CosmoPolis Electronic HID System

Garage Lighting

Page 1 of 3

GPI - Luminaire - Type IR

The Gardco GPI is a cutoff luminaire designed specifically for parking garage lighting. The Type IR rectangular lighting distribution was developed to precisely conform to the geometry of parking structures. In addition, the precision die cast aluminum canopy, the corrosion resistant acrylic housing, and the moisture, insect, and pollutant excluding silicone gasketing all assure long luminaire life. GPI luminaires provide cutoff performance.

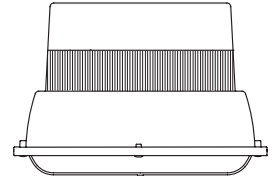

PREFIX	WATTAGE	VOLTAGE	OPTIONS
Enter the order code into the appropriate box above. Note: Philips Gardco reserves the right to refuse a configuration. Not all combinations and configurations are valid. Refer to notes below for exclusions and limitations. For questions or concerns, please consult the factory.			

PREFIX

GPI¹ Garage Luminaire

WATTAGE

Pulse Start MH Magnetic Ballast	70MH 100MH	150MH 175PSMH [ⓔ]	200MH [ⓔ]
Ceramic MH Electronic Ballast	70CMHE ³ 100CMHE ³	150CMHE ³ [ⓔ]	
CosmoPolis Electronic System	60CMPE ²	90CMPE ²	
Standard MH Magnetic Ballast*	175MH *		
High Pressure Sodium Magnetic Ballast	70HPS 100HPS	150HPS	
* 175MH not available for sale in the United States.			



Wattages marked with Circle "E" meet federal energy efficiency standards applicable to 150 watt through 500 watt metal halide luminaires only.

FINISH INFORMATION:

The upper canopy is finished with polyester powdercoat. The opaque housing section is finished with acrylic lacquer. Concrete Grey finish is standard.

VOLTAGE

120 **240** **347**
208 **277**
UNIV³ **200-277**²

OPTIONS

QS^{4,10} Quartz Standby
QST^{4,9} Quartz Standby - Timed Delay
Q924^{4,10} Quartz Emergency
QT924^{4,9} Quartz Emergency - Timed Delay
POLY⁷ Polycarbonate Downlight Lens
TP Spanner Head Tamper Resistant Screws

F Fusing
DR⁶ Supplementary Downlight Reflector
BX Bird Excluding Shroud for pendant mounted units.
JB Balanced j-box with offset knock-out
For non-rigid sway pendant mount.
LFI Lamp factory installed
IRS⁸ Instant Restrike
TM Trunnion Mount
WG Wire Guard Can be field installed.

Notes:

1. The GPI standard in Concrete Grey finish only.
2. CosmoPolis systems supplied with lamp included. CosmoPolis systems are available in 120V or 200-277V only.
3. Electronic CMHE ballasts accept 120V through 277V input. Specify "UNIV" for Voltage.
4. DC Bayonet Base, 100 watt quartz maximum. Luminaires are not available with more than 1 of the following options: QS, QST, Q924, QT924.
5. 200 through 277V, 50hz to 60hz, input. Available in CMPE types only.
6. Provides additional area illumination and masks uplight.
7. Polycarbonate lenses carry a 1 year warranty only.
8. HPS only. Contact factory prior to ordering.
9. 60CMPE and 90CMPE available with QST and QT924 Options.
10. Not Available in 60CMPE and 90CMPE.

1611 Clovis Barker Road, San Marcos, TX 78666
(800) 227-0758 (512) 753-1000 FAX: (512) 753-7855 sitelighting.com

© 2012 Koninklijke Philips Electronics N.V. All Rights Reserved.

Philips Gardco reserves the right to change materials or modify the design of its product without notification as part of the company's continuing product improvement program.

79115-72/0412

PHILIPS



DIMENSIONS

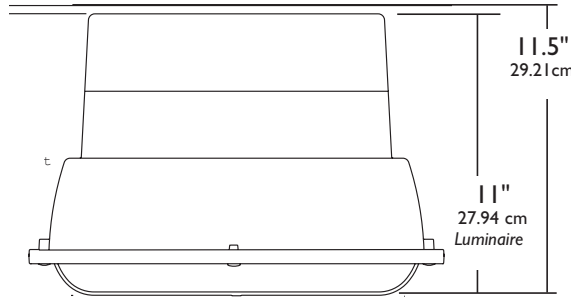
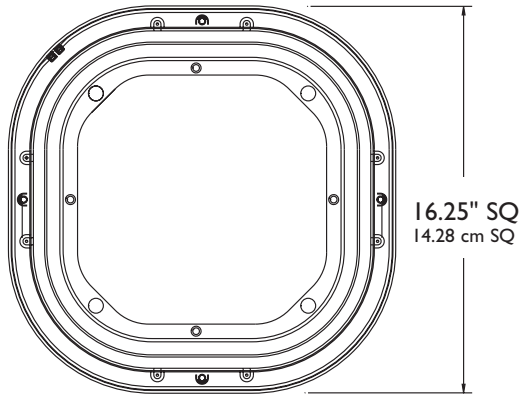

Overall
to top of
Mounting Plate

Approximate Luminaire Weight
17 lbs
7.72 kg

MOUNTING AND OPTIONS

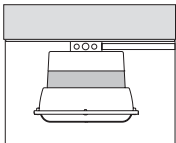

Flush or surface mounting is easily accomplished with a galvanized steel quick mount plate (standard j-box by others).

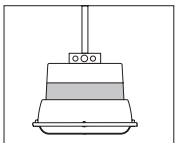

For rigid pendant mounting to conduit (by others), the Gardco Quick Mount plate is directly attached to a standard metal 4" j-box.

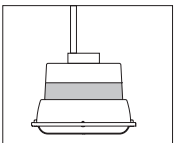

An off-set, self-leveling j-box balances the luminaire in those cases where the pendant mount is free swinging. (Swivel ceiling canopy and pendant by others.) For this option specify JB when ordering.

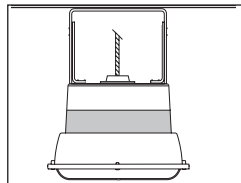

The "TM" trunnion mounting option is designed to mount to a concrete ceiling with a die formed, anodized aluminum trunnion bracket assembly. The assembly permits (6) one inch incremental mounting height adjustments. A 1/2" I.P.S. weatherproof die cast aluminum hub is located on the top pan for field attachment of rigid or flexible conduit (by others).

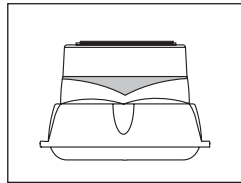

The DR (Downlight Only Reflector) option provides an additional spun aluminum lower reflector which will significantly increase pavement illumination and mask any undesired uplight. Provides additional area illumination and masks uplight. HID luminaires only.

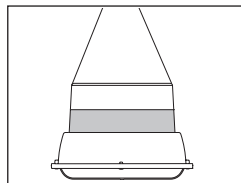

Practical options include a bird excluding shroud which prevents nesting and perching, reducing dirt and maintenance. A 12"/30.48cm minimum pendant length required.

SPECIFICATIONS

GENERAL: The Gardco GPI is a high performance garage luminaire utilizing medium base HID lamps to 200w. Units are totally sealed and suitable for damp and wet locations.

QUICK MOUNT PLATE: A die formed 14 ga. galvanized steel plate is supplied for mounting to a recessed, surface, or rigid pendant hung 4"/10.16 cm j-box (standard j-box and rigid pendant by others.) An integral hanger tab on the plate supports the luminaire during wiring.

Caution: Philips Gardco is not responsible for failure of mounting components supplied by others. Proper care should be exercised in mounting component selection to insure adequate luminaire support, given luminaire weight, vibration potential and thermal conditions present in the application. If luminaires are supported solely by screws into a composite j-box, additional support directly to structure is recommended. Failure to properly support the luminaire may cause damage or injury, for which Philips Gardco is not responsible.

UPPER ELECTRICAL CANOPY: The die cast aluminum canopy houses the ballast and wiring splices. After wiring, the canopy swings up and attaches securely to the Quick Mount Plate.

HOUSING: The housing consists of a one piece acrylic housing with prismatic upright window and opaque lower side section. The housing is fully gasketed to the upper canopy.

DOWNLIGHT REFLECTOR: Semi-specular metalized aluminum facets are precisely positioned to provide highly efficient Type IR (rectangular) lighting distributions and cutoff of source brightness at normal viewing angles.

UPLIGHT REFLECTOR: The hydroformed and anodized aluminum reflector generates illumination on the ceiling and vertical surfaces.

DOWNLIGHT LENS: An injection molded UV resistant acrylic lens is retained with captive fasteners. The lens hinges down for relamping. Memory retentive silicone gasketing seals the lens to the housing.

ELECTRICAL: High power factor magnetic HID ballasts are separate component type. Luminaires supplied with electronic metal halide ballasts will operate Ceramic Metal Halide lamps only. For luminaires provided with CosmoPolis, each high power factor ballast is electronic, designed specifically for the CosmoPolis high performance ceramic metal halide electronic system. All HID ballasts are capable of providing reliable lamp starting down to -20°F/-29°C. Component-to-component wiring within the luminaire will carry no more than 80% of rated current and is listed by UL for use at 600 VAC at 301°F/150°C or higher. Plug disconnects are listed by UL for use at 600VAC, 15A or higher. Luminaires ordered with the CosmoPolis high performance electronic system include all system components, including the lamp.

FINISH: The upper canopy is finished with polyester powdercoat. The opaque housing section is finished with acrylic lacquer. Concrete Grey finish is standard.

LABELS: All GPI luminaires bear UL or CUL (where applicable) Wet Location labels.

WARRANTY: Gardco luminaires feature a 5 year limited warranty. See Warranty Information on www.sitelighting.com for complete details and exclusions. Polycarbonate lenses carry a 1 year warranty only.

FULL CUTOFF PERFORMANCE: Full cutoff performance means a luminaire distribution where zero candela intensity occurs at an angle at or above 90° above nadir. Additionally, the candela per 1000 lamp lumens does not numerically exceed 100 (10 percent) at a vertical angle of 80° above nadir. This applies to all lateral angles around the luminaire.

CUTOFF PERFORMANCE: Cutoff performance means a luminaire distribution where the candela per 1000 lamp lumens does not numerically exceed 25 (2.5 percent) at an angle at or above 90° above nadir, and 100 (10 percent) at a vertical angle of 80° above nadir. This applies to all lateral angles around the luminaire.